

MI DRG. NO.

TF100AB04B

REV.

TF100AB04 B

HIGH POWER ALN TERMINATION (A100B-T4)

SPECIFICATIONS	FILE: TERMOUT
POWER MAX (WATTS):	100 CW
RESISTANCE	50 OHMS (±5%)

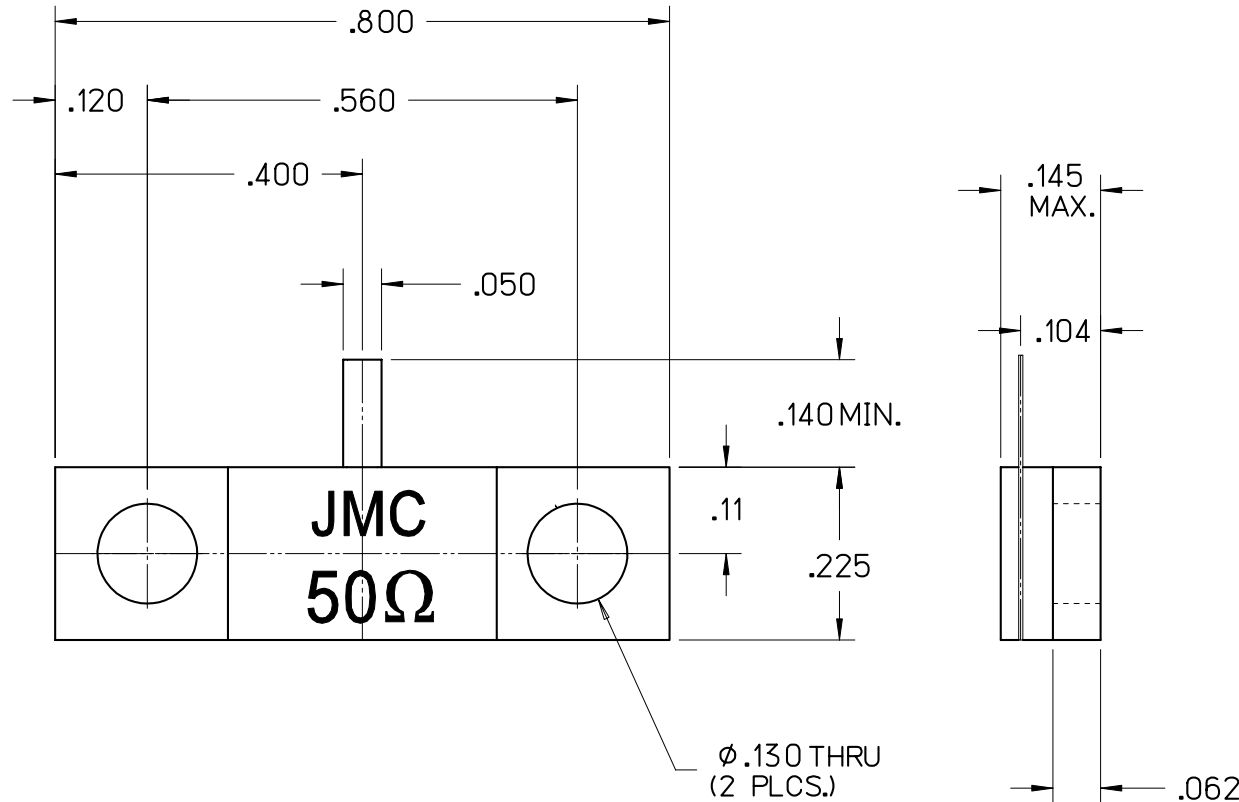

B	10/30/07	MLD	MAI	MAI	000607
A	02/20/07	MLD	-	-	000509
LEVEL	DATE	DRN.	CHK.	APP.	ECN

REVISIONS

DRN.	CHK.	APP.	SCALE
MLD	MAI	MAI	4" = 1"
DATE	DATE	DATE	.XX ± .015
02/20/07	02/21/07	02/21/07	.XXX ± .010



JOHANSON MANUFACTURING CORPORATION
 ROCKAWAY VALLEY ROAD, BOONTON, N.J. 07005 (973)334-2676 FAX (973)334-2954
 ELECTRONIC ACCURACY THROUGH MECHANICAL PRECISION

PROPRIETARY INFORMATION CONTAINED NOT TO BE USED WITHOUT JOHANSON MANUFACTURING CORPORATION APPROVAL